

Ray



Guides > Ray



Overview



The compact soundbar for music, TV, and more™

- Quick and easy setup, with only one cable to connect to your TV.
- Great sound for compact spaces™ versatile design allows you to set it on a credenza, mount it on a wall, or place it inside a TV stand.
- Stream music, radio, podcasts, and more when the TV is off.
- Expandable. Add a Sub and two Sonos speakers, like Ones, for 5.1 **surround** sound.
- Control your Sonos system with the **Sonos app** (for Android and iOS).
- See **Setup** when you're ready to add Ray to your Sonos system.

Controls and lights

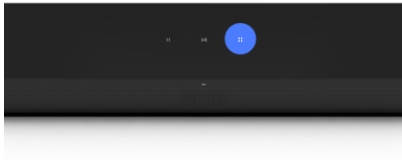

Volume control

Touch for small adjustments or touch and hold to quickly change the volume:

- Volume up (right)
- Volume down (left)

Note: You can also use the Sonos app or your TV remote.

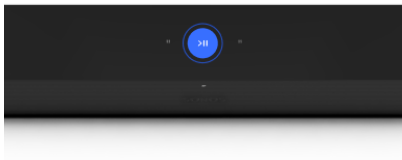

Play/Pause

Touch to play or pause audio.



Next/Previous (music only)

- Swipe right across the touch controls to skip to the next song.
- Swipe left to go to the previous song.

Note: You can't skip forward or go back when listening to a radio station.



Status light

Displays the product's connection to WiFi, indicates when the volume is muted, and signals errors. [Learn more](#)

Connector panel



1

Join button

Press to connect during setup.

2

AC power (mains) input

Use only the supplied power cord (using a third-party power cord will void your warranty).

3

Optical port

Use to connect the soundbar to your TV.

4

Ethernet port

Use an Ethernet cable if you want to connect to a router, computer, or network-attached storage (NAS) device (optional).

Select a location

You can wall mount Ray above or below your TV, or place it in or on a TV stand.

TV stand placement

- Place horizontally on a stable and level surface at least 2" (50mm) from the TV.
- Don't place vertically or on its side.
- Don't block the TV's IR sensor.
- If put on a shelf, place at the front and keep 2" (minimum) clearance on both sides for best sound quality.
- Keep 1" (25 mm) space (minimum) above Ray so you can reach the touch controls. For best sound quality, keep both ends of Ray at least 1" (25 mm) from a wall or other obstruction.
- Make sure the touch controls are facing up.

Wall mount

You can secure the soundbar to a wall with a compatible wall mount. We recommend the custom-designed Sonos Ray Wall Mount (sold separately). See [Wall mount](#) for more information.

Connect the cables

Before you start

- Disconnect existing home theater or surround sound equipment from your TV.
- Connect any external devices, like a cable box or DVD player, directly to your TV.
- Turn your TV on.

1

Connect the power cord and plug in the soundbar.

Note: Use only the supplied power cord (using a third-party power cord will void your warranty).

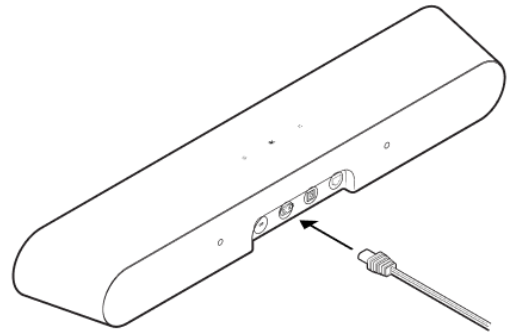

2

Remove the protective cap, then connect the optical cable (included) to the optical port on the back of your soundbar.

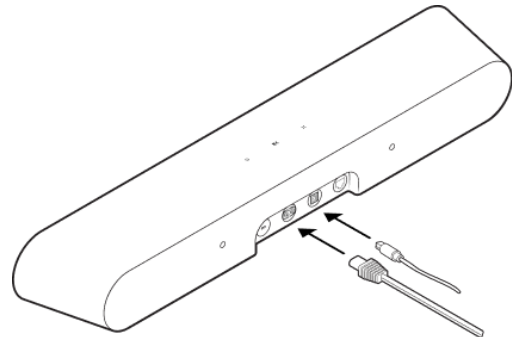

3

Remove the protective cap, then connect the optical cable to your TV's optical digital OUT port. (The TV's optical adapter's port is "D-shaped" — make sure the connector aligns correctly into the port. Inserting the adapter incorrectly may damage the cable.)

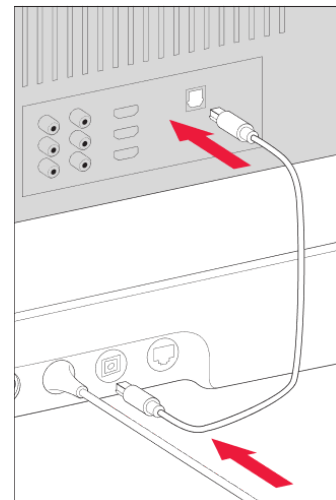

Home theater

Sonos products for your TV provide full-theater sound and play music too. Create a home theater system by adding a pair of [rear surrounds](#) and a [Sub](#).

Home theater settings

Use the Sonos app to adjust sound settings or change the way your home theater speaker works with your TV.

TV Dialog Sync

If the TV audio is out of sync with the video, you can adjust the audio delay (lip sync) in your room's settings. [Learn more](#)

Group Audio Delay

If you notice audio issues when playing to a group, you can adjust this setting. [Learn more](#)

TV Autoplay

TV Autoplay—if music or other content is playing when you turn on your TV, the audio automatically switches to TV audio (default). If you don't want this to happen, turn off TV Autoplay in your room's settings.

Ungroup on Autoplay—if your home theater speaker is grouped with other products when you turn on the TV, it automatically drops from the group (default). If you don't want this to happen, turn off Ungroup on Autoplay in your room's settings.

Speech enhancement

Makes TV dialog easier to hear. [**Learn more**](#)

Night sound

Enhances quiet sounds and reduces the intensity of loud sounds. Turn on to reduce the volume while still experiencing proper balance and range. [**Learn more**](#)

Use IR

Allow an IR remote to control Sonos.

Remote Control Setup

During setup, youâ€™ll program a remote control. You can program a different remote control any time. [**Learn more**](#)

Set up surround speakers

It's easy to turn two Sonos speakers (same model), or a Sonos Amp and your favorite non-Sonos speakers, into separate right and left channels for your home theater.

1. Place each surround speaker about 10 ft from your favorite listening position, angling them toward the seating area.
2. Go to  > **System**.
3. Select a room with a soundbar and choose **Add Surrounds** to get started.

Note: If you group the rooms or create a stereo pair instead, you won't have surround sound.

[Learn more](#)

Surround audio settings

During setup, surround sound is optimized for your room. These settings are adjustable:

Surrounds

Turn surround sound **On** or **Off**.

TV Level

Adjust surround volume for TV audio.

Music Level

Adjust surround volume for music.

Music Playback

Ambient (subtle) or **Full** (louder, full range). Doesn't apply to Dolby Atmos Music playback.

Trueplay

Every room is different. Trueplay tuning measures how sound reflects off walls, furnishings, and other surfaces in a room, then fine tunes your Sonos speaker to make sure it sounds great no matter where you've placed it.

Trueplay works on iOS mobile devices running iOS 8 or later. During tuning, you'll move around the room holding your mobile device.

1. Select  > **System**, and pick the room you want to tune.
2. Choose **Trueplay Tuning** to get started.

Note: Trueplay tuning isn't available if VoiceOver is enabled on your iOS device. Turn VoiceOver off in your device settings before tuning your speakers.

Auto Trueplay

Portable Sonos products like Sonos Roam and Move can tune themselves automatically. Auto Trueplay uses your speaker's microphone to detect the environment and make periodic tuning adjustments so you get great sound wherever your speaker is and whatever you're listening to.

Go to  > **System**, and select your portable speaker to turn on auto Trueplay.

Product settings

You can customize Sonos products for your surroundings. Go to  > **System** and select a product.

Room Name

If you move your speaker to a new room, you can change its name in **Settings**.

Turn off WiFi

(not available for Era 100, Era 300 or portable products)

You can turn off your speaker's WiFi when it's connected to your network with an Ethernet cable. This reduces power consumption and can improve connectivity for some wired speakers. For products like Amp and Port, turning off WiFi can reduce the internal temperature when they're placed in a rack or stacked. [Learn more](#)

EQ

Sonos products ship with preset equalization settings. You can change the sound settings (bass, treble, balance, or loudness) to suit your personal preferences. [Learn more](#)

Trueplay

Trueplay adapts the sound for your surroundings and content. Portable products can tune themselves automatically. [Learn more](#)

Volume Limit

You can set a maximum volume for each room. [Learn more](#)

Status Light

Displays the speaker's connection to WiFi, indicates when the volume is muted, and signals errors. [Learn more](#)

Note: If the light is distracting, you can turn it off in **Settings**.

Touch Controls

You can disable the touch control on your speaker. You may want to do this to prevent a child or curious pet from accidentally adjusting playback or volume.

[Learn more](#)

Battery Saver (for portable products only)

To save battery life, you can set your portable speaker to power off automatically instead of going to sleep. It won't appear in the Sonos app until it's powered back on.

When a projector, turntable, stereo, or other audio device is connected to a Sonos product, you can adjust these line-in settings:

- **Source name:** Choose a name for the line-in device.
- **Source level:** Adjust the line-in source level if you find the default volume setting is too quiet or distorted.
- **Audio Delay:** Add a delay between the line-in source and Sonos to reduce the chance of audio issues occurring when you're playing line-in audio on grouped speakers.
- **Autoplay:** Choose a room if you want line-in audio to start playing automatically when Sonos detects a signal on the line-in port. (Autoplay is disabled by default.)

Line-In

(for Sonos products with line-in capability)

Accessories

Find the perfect accessory for your Sonos system—tailored to perfectly fit your Sonos products.

For a full selection of Sonos-compatible stands, wall mounts, chargers and cables, see [Accessories](#) on our website.

Wall mount

Use the Ray wall mount kit (sold separately, available at [sonos.com](https://www.sonos.com)). It's designed for mounting on a flat wall.

Guidelines

- Leave enough space between Ray and your TV so you can reach Ray's touch controls.
- For best sound quality, keep both ends of Ray at least 1' (30cm) from a wall or other obstruction.

Mount kit contents

- Wall mount bracket
- 2 short attachment screws
- 2 wall anchors
- 2 wall screws

What you'll need

- Pencil
- Phillips-head screwdriver
- Power drill (if needed for installation location)
- Measurement tool
- Level
- Stud finder (optional)

Wall mount	Pre-drill	Use wall anchors	Use screws
Wood stud	1/8" / 3mm bit	No	Yes
Drywall (no stud)	5/16" / 8mm bit	Yes	Yes
Hard wallboard or double board	5/16" / 8mm bit	Yes	Yes
Plaster	5/16" / 8mm bit	Yes	Yes
Concrete or brick	5/16" / 8mm bit	Yes	Yes

Set it up

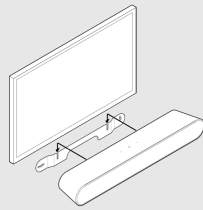

1

If your TV is wall-mounted, align the top edge of the bracket with the bottom of your TV, leaving at least 2.5 inches (mm) between them.

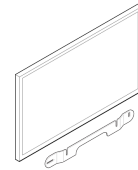

2

Mark the screw locations and remove the bracket.

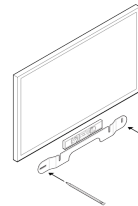

3

If you're using wall anchors, use a 5/16" drill bit to drill pilot holes, starting with the hole on the left. Then insert the wall anchors. Don't use wall anchors if you're drilling into wood or plastic. See [**Wall mounting information**](#).

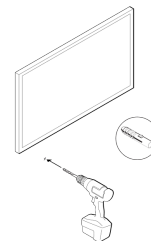

4

Position the wall mount bracket over the screw locations, using a level to confirm accuracy. Use a Phillips-head screwdriver or a power drill to screw the bracket to the wall, making sure the center notch is pointing up.

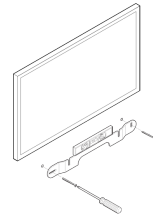

5

Using a Phillips head screwdriver, fasten the 2 attachment screws to the back of the soundbar, making sure they are fully tightened.

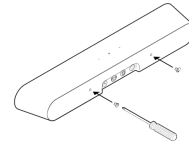

6

Remove the protective cap from the optical cable, then connect the power and optical cables to the back of the soundbar.

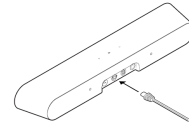

7

Slide the soundbar down so the attachment screws fit into the slots on the wall bracket. Make sure the touch controls are facing up and Sonos Ray is fully seated.

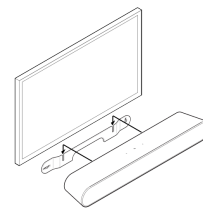

Specifications

Feature

Description

AUDIO

Amplifiers

Four Class-D digital amplifiers.

Woofers

Two full-range woofers ensure youâ€™ll hear the faithful playback of mid-range vocal frequencies plus deep, rich bass.

Tweeters

Two tweeters create a crisp and clear high-frequency response.

Audio ports

Two micro ports with proprietary anti-distortion technology.

Adjustable EQ

Use the Sonos app to adjust bass, treble, and loudness.

SOFTWARE

Sonos S2

Set up and control with the latest generation of the Sonos app.

Apple AirPlay 2

Works with AirPlay 2 on apples devices iOS 11.4 and higher.

Feature	Description
Trueplay	Dynamically tunes the speaker to the unique acoustics of the room or area (iOS device required).
Speech enhancement	Turn on this home theater setting in the Sonos app to make TV dialogue even clearer.
Night sound	Turn on this home theater setting to reduce the intensity of loud TV sound effects.
System requirements	TV with optical digital audio output, broadband internet, and the Sonos app.
GENERAL	
Dimensions (H x W x D)	2.79 x 22.00 x 3.74 in (71 x 559 x 95mm)
Colors	Black, white
Finish	Matte
Weight	4.29 lb (1.95 kg)
Speaker status light	Displays the speaker's connection to WiFi, indicates when the volume is muted, and signals errors.

Feature	Description
Operating temperature	32°F to 104°F (0°C to 40°C)
Storage temperature	-4°F to 122°F (-20°C to 50°C)
Control	Use your IR (infrared-enabled) TV remote control, touch controls or the Sonos app.
CPU	Quad Core; 1.4 GHz A-53
Memory	1 GB SDRAM; 4GB NV
Mounting	M5 threaded mounting socket
POWER & CONNECTIVITY	
Power supply	Auto-switching 100-240 V, 50-60 Hz 2.0A AC universal input.
WiFi	Connects to WiFi network with any 802.11b/g/n, 2.4 GHz broadcast-capable router.
Optical	Use the included optical cable to connect the soundbar to your TV's optical digital audio output.

Feature**Description**

Ethernet

One port for hardwiring to your router (optional).

Infrared receiver

Syncs with your TV remote for streamlined control.

Supported devices

Connects to TV with optical cable. Plays sources connected to the TV, including cable boxes and game consoles.

- Specifications subject to change without notice.

Important safety information

1. Read these instructions.
2. Keep these instructions.
3. Heed all warnings.
4. Follow all instructions.
5. Do not use this apparatus near water.
6. Clean only with dry soft cloth. Household cleaners or solvents can damage the finish on your Sonos products.
7. Do not block any ventilation openings. Install in accordance with the manufacturer's instructions.
8. Do not install near any heat sources such as radiators, heat registers, stoves, or other apparatus that produce heat.
9. Protect the power cable from being walked on or pinched, particularly at plugs, convenience receptacles, and the point where they exit from the apparatus.
10. Only use attachments/accessories specified by the manufacturer.
11. Unplug this apparatus during lightning storms or when unused for long periods of time.
12. This product does not have any user-serviceable parts. Do not open or disassemble or attempt to repair it or replace any components. Refer all servicing to Sonos qualified service personnel. Servicing is required when the apparatus has been damaged in any way, such as power-supply cable or plug is damaged, liquid has been spilled or objects have fallen into the apparatus, the apparatus has been exposed to rain or moisture, does not operate normally, or has been dropped.
13. The Mains plug should be readily available to disconnect the equipment.
14. **Warning:** To reduce the risk of fire or electric shock, do not expose this apparatus to rain or moisture.
15. Do not expose apparatus to dripping or splashing and do not place objects filled with liquids, such as vases, on the apparatus.